

Linear

# MOMO-L RGBW Fixture Guide

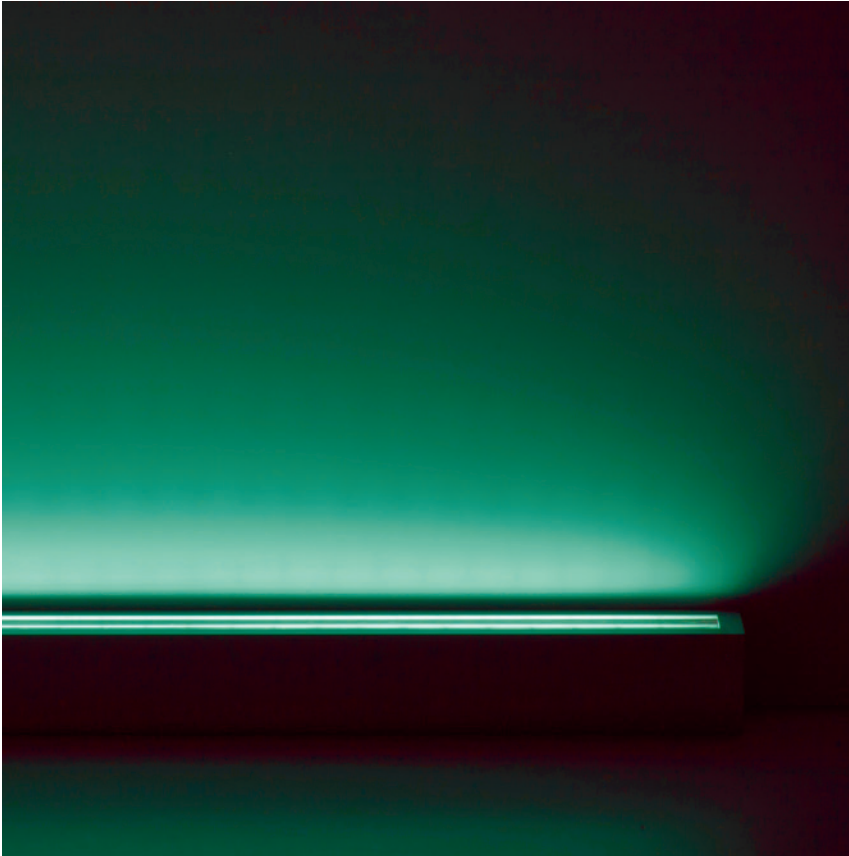

Indoor/Outdoor | Surface | RGBW output up to 973lm/m (297lm/ft)



## Key applications

- ✓ Architectural detail
- ✓ Backlighting & signage
- ✓ Bathrooms
- ✓ Building facades
- ✓ Direct lighting
- ✓ Exterior
- ✓ Interior
- ✓ Mirror back lighting
- ✓ Retail display
- ✓ Special effect
- ✓ Window reveal
- ✓ Wet area

## Key features

- ✓ Adjustable
- ✓ Custom lengths
- ✓ Constant Voltage (CV)
- ✓ Diffusion: homogenous
- ✓ Direct view
- ✓ Extensive CCT range
- ✓ Glare control options
- ✓ IP44 moisture resistant
- ✓ IP67 waterproof
- ✓ LEDmix RGBW

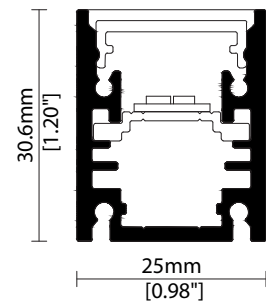

## MOUNTING METHODS



KKCP-03 Clip



KKCP-17 Lock clip



KKBK-07 Fixing plate



KKBK-21 Adjustable bracket

Linear

# MOMO-L RGBW

## Specification sheet



<b>Dimensions</b>	H30.6/W25/L155-2030mm (H1.2/W0.98/L6.10-79.92in)
<b>PCB Cut-point</b>	62.5mm increment/2000mm max (2.46in increment/78.74in max)
<b>LED Pitch</b>	10.4mm-192LED/m (0.41in - 59LED/ft)
<b>Chip</b>	RGBW LEDmix
<b>Cover/Optics</b>	Clear (100°)/Clear + Micro louvre/Diffused (95°)
<b>CCT</b>	<b>s-line:</b> White: 1900K/2100K/2300K/2500K/2700K/3000K/3500K/4000K/5000K <b>RGB:</b> Red 620-625nm/Blue 455-460nm/Green 520-525nm <b>k-line:</b> White: 1900K/2100K/2300K/2500K/2700K/3000K/3500K/4000K/5000K <b>RGB:</b> Red 617-627nm/Blue 464-474nm/Green 515-525nm
<b>LED binning</b>	<b>s-line:</b> White: 2.5-step MacAdam ellipse / RGB: 5nm tolerance <b>k-line:</b> White: 3-step MacAdam ellipse / RGB: 10nm tolerance
<b>CRI</b>	≥ 90 (white only)
<b>Lifetime</b>	50,000 hours @ 25°C (50,000 hours @ 77°F)
<b>Operating temp</b>	T <sub>a</sub> = -25 to 50°C (T <sub>c</sub> max = 70°C) T <sub>a</sub> = -13 to 122°F (T <sub>c</sub> max = 158°F)
<b>IP Rating</b>	IP44/67
<b>Finish</b>	Silver anodised
<b>Mounting</b>	Surface mounting via clips or brackets
<b>Power feed</b>	Sheathed hardwire tails or male/female connectors
<b>Control</b>	DMX/DALI



### LED Grading Key

#### Exclusive Grade

**s-line\***  
2-step CCT range

\*KKDC tuned  
CCT range

#### Base Grade

**k-line**  
3-step commercial range  
Energy Star CCTs

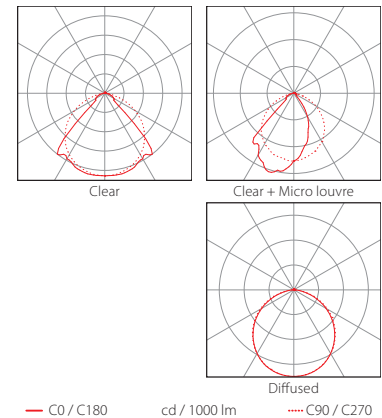
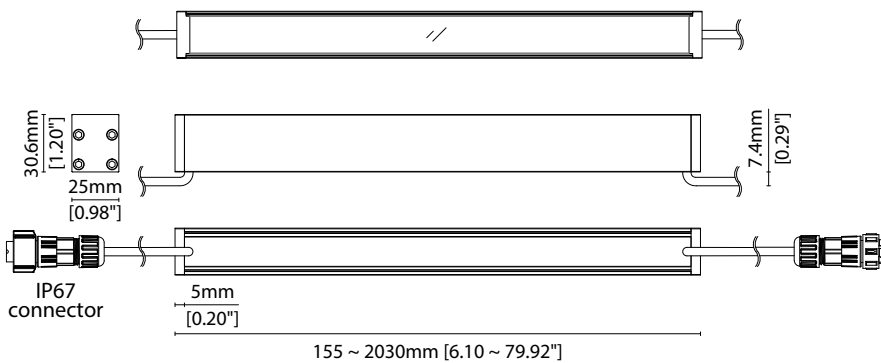

<b>Power consumption</b>	<b>Supply voltage</b>	<b>Supply current</b>
20W/m (6.10W/ft)	24V DC	0.83A/m (0.25A/ft)

	Clear	Clear + Micro Louvre	Diffused Cover
<b>s-line</b>	973lm/m (297lm/ft) 48.7lm/W	283lm/m (86lm/ft) 14.2lm/w	435lm/m (132lm/ft) 21.7lm/W
<b>k-line</b>	918lm/m (280lm/ft) 45.9lm/W	267lm/m (81lm/ft) 13.4lm/w	410lm/m (125lm/ft) 20.5lm/W



Data derived from independent UKAS / IESNA LM-79-08 accredited testing of production samples.

### FIXTURE

Model	Finish	Cover/Lens <sup>1</sup>	Grade <sup>2</sup>	LED	Colour (CCT)	Length Availability <sup>3</sup>	IP	Cable Length	Power Feed <sup>4</sup>	Input	
MOMO-L	MO Silver Anodised	SA Clear	B	 s	R201	RGB+1900K 19	m 155-2020mm 62.5mm increments	300mm/ 11.81"	IP44 44 IP67 <sup>6</sup> 67	Single ø5.5mm sheath tail S00E DC 24V	
			K	 k	R201	RGB+2100K 21					
			C		R201	RGB+2300K 23					
		Clear + Micro Louvre					RGB+2500K 25	i 6.10-79.92in 2.46in increments  (Specify length code OR total run length)			Double ø5.5mm sheath tail D00E
							RGB+2700K 27				
							RGB+3000K 30				
		Diffused					RGB+3500K 35				Single ø5.5mm sheath IP67 Male Connector S67F
							RGB+4000K 40				
							RGB+5000K 50				

<sup>1</sup> Refer to **Cover/Lens Options** on **Options** pages    <sup>2</sup> Refer to **LED Grading Key** on **Specification sheet** page    <sup>3</sup> Refer to **Length Availability List** or enter total run length instead of length code

<sup>4</sup> Refer to **Power Feed Options** on **Options** pages    <sup>5</sup> LEDmix RGBW requires white colour choice

<sup>6</sup> Due to the clear, flush potted polyurethane top layer on IP67 MOMO-L a colour shift of +/-20K should be expected

### Code Example:

MO	-	SA	-	C	-	s	-	R201	-	RGBW	-	35	-	m	530	-	44	-	0300	-	D00E	-	g
MOMO-L		Silver Anodised		Diffused				R201		RGBW		RGB+3500K		530mm		IP44		300mm/11.81"		Double ø5.5mm sheath tail		DC 24V	

### ACCESSORIES

#### Mounting Accessories

KKCP-03	Clip (1no.)
KKCP-53	Clip (500na.)
KKCP-09	Lock Clip
KKBK-07	Fixing plate
KKBK-21	Adjustable bracket

\* Refer to **Mounting accessories** on **Accessories** pages

#### Connection Accessories

CN67-5P-0300	IP67 5 PIN male & female 300mm/11.81" pair
CN67-5P-1000	IP67 5 PIN male & female 1000mm/39.37" pair
CN67-5P-3000	IP67 5 PIN male & female 3000mm/118.11" pair

\* Refer to **Power feed** on **Accessories** pages

#### Exterior Junction Boxes

KKJB-07	IP67 Slim J-Box
KKJB-07R	Potting Resin for IP67 Slim J-Box

\* Refer to **Exterior Junction Boxes** on **Accessories** pages

#### PSU/Driver

DALI/DMX

\* Refer to **Driver/PSU Options** page for details or provide requirement and KKDC to offer the suitable option

### LED ENGINE VARIANTS (LED STRIP TYPE)

Colour	LED	Lumen/m	Lumen/ft	W/m	W/ft	Spec Doc	Length	Increment
Single CCT	R007	557	170	7	2.13	MOMO-L R007	103.3-2020mm (4.05-79.52in)	41.7mm (1.64in)
	R014	1140	374	14	4.27	MOMO-L R014	103.3-2020mm (4.05-79.52in)	41.7mm (1.64in)
	R020	1615	492	20	6.10	MOMO-L R020	103.3-2020mm (4.05-79.52in)	41.7mm (1.64in)
	R030	2286	697	30	9.14	MOMO-L R030	103.3-2020mm (4.05-79.52in)	41.7mm (1.64in)
	A040	3640	1109	40	12.19	MOMO-L A040	97-1520mm (3.82-59.84in)	38.46mm (1.51in)
	Warm Dim/Dynamic White	R207	1289	393	16	4.88	MOMO-L R207	103.3-2020mm (4.05-79.52in)
RGB	501	Red 125 Green 266 Blue 42 RGB 383	Red 38 Green 81 Blue 13 RGB 117	15.6	4.75	MOMO-L RGB	103.3-2020mm (4.05-79.52in)	83.3mm (3.28in)
<b>RGBW</b>	<b>R201</b>	<b>973</b>	<b>297</b>	<b>20</b>	<b>6.1</b>	<b>MOMO-L RGBW</b>	<b>155-2030mm (6.10-79.92in)</b>	<b>62.5mm (2.46in)</b>

\* Performance data: s-line, clear cover, 3000K+RGB

# MOMO-L RGBW

## Length Availability List



Length Code		Fixture Length <sup>1</sup>		LED Strip <sup>2</sup>		End Cap Dimension <sup>3</sup>		Wattage (W)	Output (lm)
Metric	Imperial(US)	Metric	Imperial(US)	Metric	Imperial(US)	Metric	Imperial(US)		3000K (Test Data)
m0155	i0006	155mm	6.10in	125mm	4.92in	10mm	0.39in	2.50	115
m0218	i0009	218mm	8.56in	188mm	7.38in	10mm	0.39in	3.75	172
m0280	i0011	280mm	11.02in	250mm	9.84in	10mm	0.39in	5.00	230
m0343	i0013	343mm	13.48in	313mm	12.30in	10mm	0.39in	6.25	287
m0405	i0016	405mm	15.94in	375mm	14.76in	10mm	0.39in	7.50	344
m0468	i0018	468mm	18.41in	438mm	17.22in	10mm	0.39in	8.75	402
m0530	i0021	530mm	20.87in	500mm	19.69in	10mm	0.39in	10.00	459
m0593	i0023	593mm	23.33in	563mm	22.15in	10mm	0.39in	11.25	516
m0655	i0026	655mm	25.79in	625mm	24.61in	10mm	0.39in	12.50	574
m0718	i0028	718mm	28.25in	688mm	27.07in	10mm	0.39in	13.75	631
m0780	i0031	780mm	30.71in	750mm	29.53in	10mm	0.39in	15.00	689
m0843	i0033	843mm	33.17in	813mm	31.99in	10mm	0.39in	16.25	746
m0905	i0036	905mm	35.63in	875mm	34.45in	10mm	0.39in	17.50	803
m0968	i0038	968mm	38.09in	938mm	36.91in	10mm	0.39in	18.75	861
m1030	i0041	1030mm	40.55in	1000mm	39.37in	10mm	0.39in	20.00	918
m1093	i0043	1093mm	43.01in	1063mm	41.83in	10mm	0.39in	21.25	975
m1155	i0045	1155mm	45.47in	1125mm	44.29in	10mm	0.39in	22.50	1033
m1218	i0048	1218mm	47.93in	1188mm	46.75in	10mm	0.39in	23.75	1090
m1280	i0050	1280mm	50.39in	1250mm	49.21in	10mm	0.39in	25.00	1148
m1343	i0053	1343mm	52.85in	1313mm	51.67in	10mm	0.39in	26.25	1205
m1405	i0055	1405mm	55.31in	1375mm	54.13in	10mm	0.39in	27.50	1262
m1468	i0058	1468mm	57.78in	1438mm	56.59in	10mm	0.39in	28.75	1320
m1530	i0060	1530mm	60.24in	1500mm	59.06in	10mm	0.39in	30.00	1377
m1593	i0063	1593mm	62.70in	1563mm	61.52in	10mm	0.39in	31.25	1434
m1655	i0065	1655mm	65.16in	1625mm	63.98in	10mm	0.39in	32.50	1492
m1718	i0068	1718mm	67.62in	1688mm	66.44in	10mm	0.39in	33.75	1549
m1780	i0070	1780mm	70.08in	1750mm	68.90in	10mm	0.39in	35.00	1607
m1843	i0073	1843mm	72.54in	1813mm	71.36in	10mm	0.39in	36.25	1664
m1905	i0075	1905mm	75.00in	1875mm	73.82in	10mm	0.39in	37.50	1721
m1968	i0077	1968mm	77.46in	1938mm	76.28in	10mm	0.39in	38.75	1779
m2030	i0080	2030mm	79.92in	2000mm	78.74in	10mm	0.39in	40.00	1836

<sup>1</sup> Actual total overall length of light fixture (LED strip + end caps + void/wire hole)

<sup>2</sup> Actual length of PCB strip

<sup>3</sup> Actual length of 2x end caps

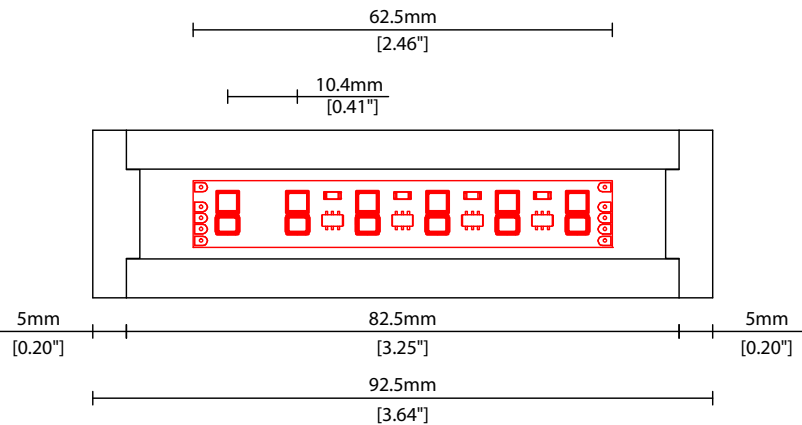

### COVER/LENS OPTIONS

\* Options are an integral part of the fixture ordering codes. Please refer to **Code Table** pages.



**B** Clear Cover  
W25.0/H30.6mm (W0.98/H1.20")

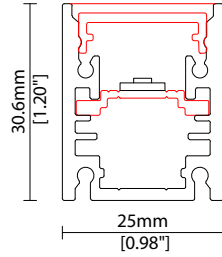

**K** Clear Cover + Micro Louvre  
(diffused internal cover)  
W25.0/H30.6mm (W0.98/H1.20")

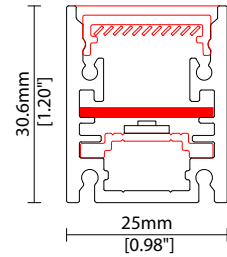

**C** Diffused Cover  
W25.0/H30.6mm (W0.98/H1.20")

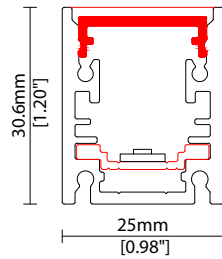

### POWER FEED OPTIONS

0300 S00E 300mm (11.81") Single Ø5.5mm sheath tail

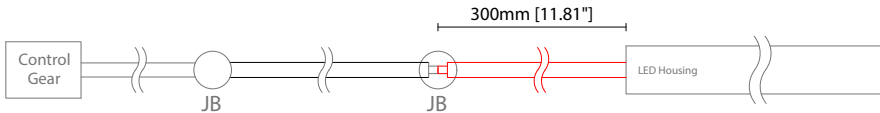

0300 D00E 300mm (11.81") Double Ø5.5mm sheath tail

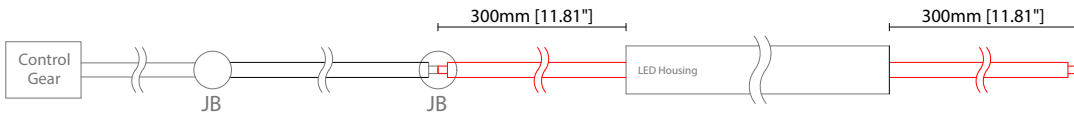

0300 S67F 300mm (11.81") Single Ø5.5mm sheath IP67 connector

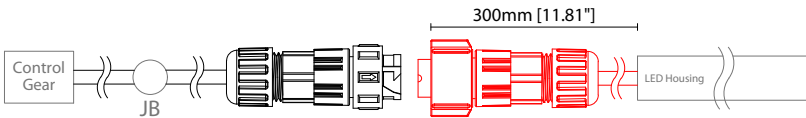

0300 D67F 300mm (11.81") Double Ø5.5mm sheath IP67 connector

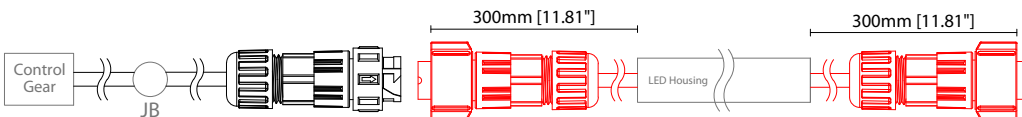

#### Key

Control Gear	Power supply, sub-controllers & control systems
JB	Junction box / cable connection

## MOUNTING ACCESSORIES

Note: Accessories are to be ordered separately with corresponding code shown below.



**KKCP-03** (1no.)  
**KKCP-53** (500no.)  
 Clip (allow 3 per metre/40in)  
 S/Steel finish  
 L25/W33.1/H33.5mm  
 (L0.98/W1.3/H1.32")

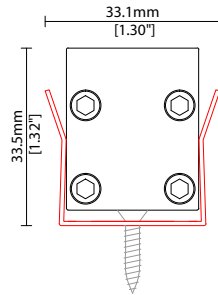

**KKCP-17**  
 Lock clip (allow 2 per metre/40in)  
 S/Steel finish  
 L25/W26.1/H45mm  
 (L0.98/W1.03/H1.77")

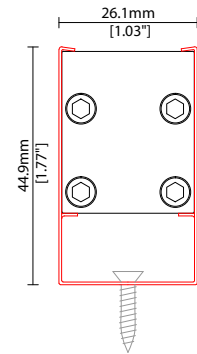

**KKBK-07**  
 Fixing plate (allow 2 per metre/40in)  
 Anodised aluminium finish  
 L50/W25/H38mm  
 (L1.97/W0.98/H1.5")  
 Pre-assembled in factory

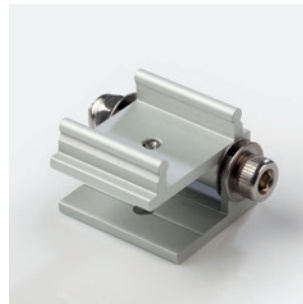
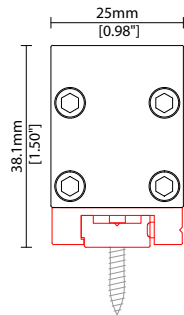

**KKBK-21**  
 Adjustable bracket (allow 2 per metre/40in)  
 Anodised aluminium finish  
 L34/W25/H41.9mm  
 (L1.34/W0.98/H1.65")  
 Pre-assembled in factory

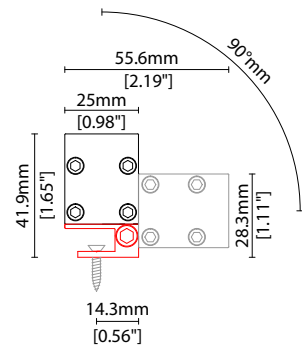

## POWER FEED

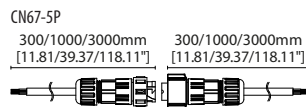

**CN67-5P**  
**CN67-5P-0300** 300mm (11.81in) pair  
**CN67-5P-1000** 1000mm (39.37in) pair  
**CN67-5P-3000** 3000mm (118.11in) pair  
 IP67  
 5 PIN male + female (RGBW) connector set

### EXTERIOR JUNCTION BOXES



**KKJB-07**

IP67 Slim J-Box  
(including type A,B,C,D bushings)



**KKJB-07R**

Potting resin for IP67 Slim J-Box

### KKDC CONTROL



**KKDM-06** 1-10V

visDIM dimmable sub-controller  
(4 x 8A max @ 12-36V)

IP20  
Plastic housing  
L170/W59/H29mm  
(L6.69/W2.32/H1.14in)



**KKSC-05** DMX

visDIM dimmable sub-controller  
(4 x 5A max @ 12-36V)

IP20  
Plastic housing  
L170/W53.4/H28mm  
(L6.69/W2.10/H1.10in)



**KKDL-02** DALI

visDIM dimmable sub-controller  
(4 x 8A max @ 12-36V)

IP20  
Plastic housing  
L170/W59/H29mm  
(L6.69/W2.32/H1.14in)



**KKDL-03** DALI

visDIM dimmable sub-controller  
(4 x 5A max @ 12-36V)

IP20  
Plastic housing  
L166/W53.4/H23mm  
(L6.54/W2.10/H0.91in)



### AVAILABLE PSU OPTIONS

Control Mode	PSU (Order Code)	Input Voltage AC	Output Voltage DC	Rated Output Current	Rated Power	Dim %	IP Rating
Switched	CEN-60-24	90-295V	24V	2.5A	60W	-	IP67
	HLG-60H-24	90-305V	24V	2.5A	60W	-	IP67
	HLG-100H-24	90-305V	24V	4.0A	100W	-	IP67
	HLG-150H-24	90-305V	24V	6.3A	150W	-	IP67
	HLG-240H-24	90-305V	24V	10A	240W	-	IP67
0-10V (1-10V)	PWM-40-24	90-305V	24V	1.67A	40W	100-0.15 (100-10)	IP67
	PWM-60-24	90-305V	24V	2.5A	60W	100-0.15 (100-10)	IP67
	PWM-90-24	90-305V	24V	3.67A	90W	100-0.15 (100-10)	IP67
	PWM-120-24	90-305V	24V	5.0A	120W	100-0.15 (100-10)	IP67
DALI	LIN100A1	120-277V	24V	1A per channel	100W	100-0.1	IP66/IP40
DMX RGB	LIN100A1	120-277V	24V	1.33A per channel	100W	100-0.1	IP66/IP40
DMX RGBW	LIN100A1	120-277A	24V	1A per channel	100W	100-0.1	IP66/IP40

### Flicker Free Options - Combination of PSU+ sub-controller

Control Mode	PSU (Order Code)	Sub-controller (Order Code)	Input Voltage AC	Output Voltage DC	Rated Output Current	Rated Power	Dim %	IP Rating PSU/ Sub-controller
0-10V or 1-10V	CEN-60-24	KKDM-06	90-295V	24V	2.5A	60W	100-0.9	IP67/IP20
	HLG-60H-24	KKDM-06	90-295V	24V	2.5A	60W	100-0.9	IP67/IP20
	HLG-100H-24	KKDM-06	90-295V	24V	4.0A	100W	100-0.9	IP67/IP20
	HLG-150H-24	KKDM-06	90-295V	24V	6.3A	150W	100-0.9	IP67/IP20
	HLG-240H-24	KKDM-06	90-295V	24V	10.0A	240W	100-0.9	IP67/IP20
DALI	CEN-60-24	KKDL-02/03	90-295V	24V	2.5A	60W	100-0.1	IP67/IP20
	HLG-60H-24	KKDL-02/03	90-305V	24V	2.5A	60W	100-0.1	IP67/IP20
	HLG-100H-24	KKDL-02/03	90-305V	24V	4.0A	100W	100-0.1	IP67/IP20
	HLG-150H-24	KKDL-02/03	90-305V	24V	6.3A	150W	100-0.1	IP67/IP20
	HLG-240H-24	KKDL-02/03	90-305V	24V	10.0A	240W	100-0.1	IP67/IP20
DMX RGB	CEN-60-24	KKSC-05	90-295V	24V	2.5A	60W	100-0.9	IP67/IP20
	HLG-60H-24	KKSC-05	90-305V	24V	2.5A	60W	100-0.9	IP67/IP20
	HLG-100H-24	KKSC-05	90-305V	24V	4A	100W	100-0.9	IP67/IP20
	HLG-150H-24	KKSC-05	90-305V	24V	6.3A	150W	100-0.9	IP67/IP20
	HLG-240H-24	KKSC-05	90-305V	24V	10.0A	240W	100-0.9	IP67/IP20

<sup>1</sup> The items shown above cover the most frequently used specification but does not exhaust the possible options

<sup>2</sup> PSU and/or driver can be chosen from the table, or KKDC may recommend the best option upon receipt of the controls requirement and installation environment

<sup>3</sup> Electrical shop drawing will include detailed information of PSU and relevant control drivers

<sup>4</sup> Cut sheets are available on the controls section of [www.kkdc.lighting](http://www.kkdc.lighting) or upon request